

version .0

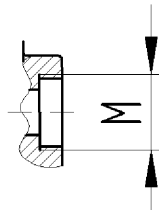
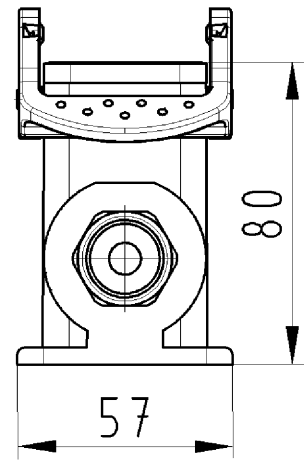
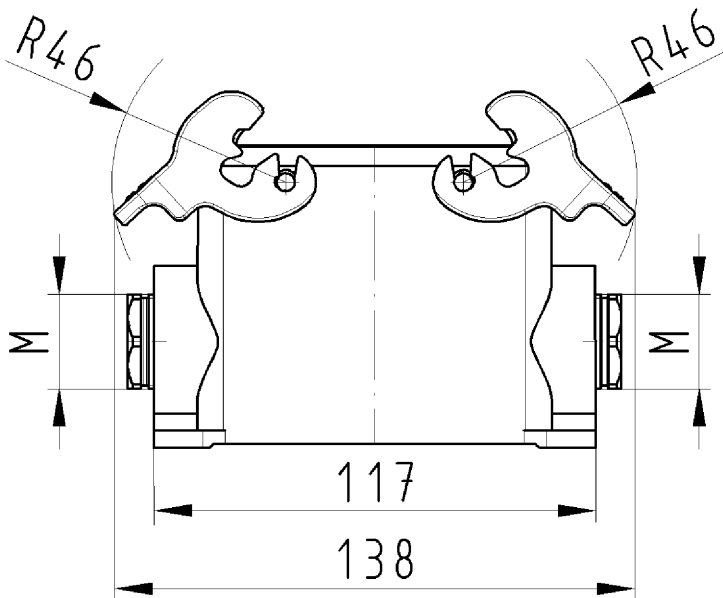

version .1

Gehäuseunterteil
73.330.4035.0

Zeichnungsnummer
73.330.4035.010W
Gehäuseunterteil

13.12.2007
Hoffmann Angelika
M 1:2